



ALLin

ALLin is a chair program built around a distinctively refined shell seat. The program offers a variety of structures and frames to support the seat, including metal, wood, and aluminum options. Thanks to the universal mounting system integrated beneath the seat, the program has limitless potential — from stackable chairs and wooden chair structures to even stadium seating. The chairs are suitable for both indoor and outdoor use, with the handle features doubling as a water drain for outdoor settings. Designed for strength and easy maintenance.

MODEL

AL4020

DIMENSIONS

Height - 74 cm

Width - 48 cm

Depth - 53 cm

MATERIALS

- 100% recycled Polyethylen
+ Color Recycling Program
- UV stabilizer
- Anti-microbial

DESIGNER

- Studio Rygalik

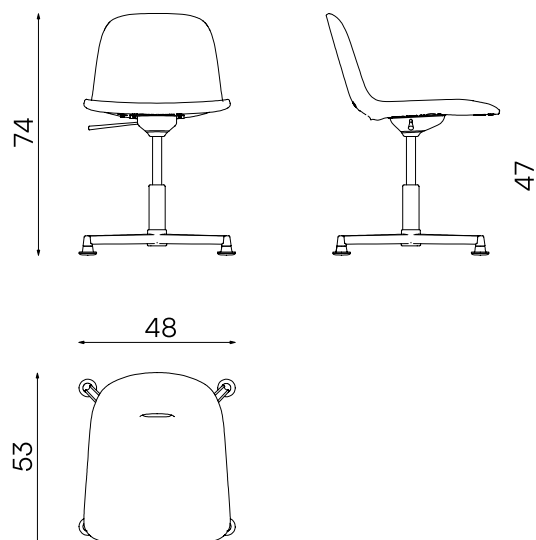

AVAILABLE COLOR VERSIONS



YellowBlack

BrownBlack

BlackBrown

YellowBeige

GreyBeige

COLOR RECYCLING PROGRAM

LOOPE redefines design - pioneering 100% circular technology to craft thoughtful, timeless, furniture solutions for a better life and a sustainable future.

Technology and material innovation are at the heart of LOOPE, offering endless possibilities. Plastic is often controversial, but our project proves that it can be used responsibly. We manufacture furniture from 100% pre-consumer recycled polyethylene, ready to be recycled repeatedly under controlled conditions. Sourced from fully valuable material left over from the production of planters, kayaks and other large-format elements made in our factory in Poland. This material returns to circulation in the form of durable furniture, instead of ending up as waste.

With full control over the recycling process, we ensure the polyethylene remains uncontaminated and, under controlled conditions, retains its key properties. This exceptional material is resistant to weather, scratches, breaks, and impacts. It's flexible, soft, yet incredibly durable extending the life of each piece.

ADDITIONAL INFORMATION

MAINTENANCE

- Products can be cleaned with warm water and a mild detergent.
- Avoid using harsh cleaning agents that may damage the surface.

TEMPERATURE RESISTANCE

- High-quality polyethylene retains its properties in temperatures ranging from -30°C to +60°C.

WARRANTY

- LOOPE is more than just furniture - it's a thoughtful system that redefines consumption.
- After five years, customers can return their furniture, and we'll transform it into a new product. This way, we extend its life and reduce plastic production. Warranty covers color and shape deformation.

DIGITAL FILE BASE

- PHOTOS
- VISUALIZATIONS
- 2D & 3D FILES