



ROUNDER

ROUNDER is a timeless and robust icon designed for semi-public spaces, crafted from 100% recycled materials. The chair features a circular geometric seat, softened by a friendly, approachable rim, and is firmly supported by a central pillar. The two components are designed to be easily assembled and disassembled, facilitating convenient shipping and storage while enabling a wide range of functional and color combinations. ROUNDER is a versatile furniture system consisting of supporting pillars and tabletops in various sizes. The tabletops can be paired with different pillar heights, offering a broad range of configuration options and color variations. A distinctive rim detail enhances the comfort and ease of handling the tabletops, while a corresponding foot detail on the floor reinforces the cohesive and consistent character of the collection.

MODEL

RO1050

DIMENSIONS

Height - 72 cm

Width - 60 cm

Depth - 60 cm

MATERIALS

- 100% recycled Polyethylen
+ Color Recycling Program
- UV stabilizer
- Anti-microbial

DESIGNER

- Studio Rygalik

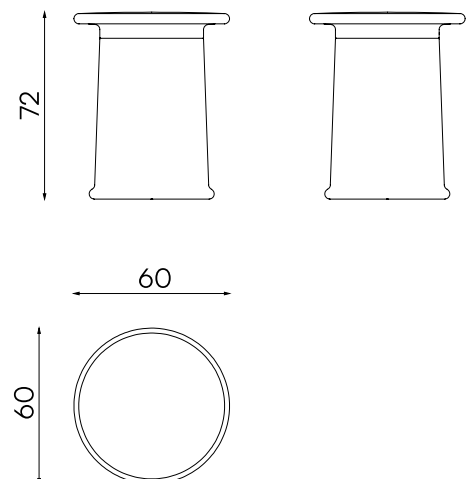

AVAILABLE COLOR VERSIONS



YellowBlack



BrownBlack



BlackBrown



YellowBeige



GreyBeige

COLOR RECYCLING PROGRAM

LOOPE redefines design - pioneering 100% circular technology to craft thoughtful, timeless, furniture solutions for a better life and a sustainable future.

Technology and material innovation are at the heart of LOOPE, offering endless possibilities. Plastic is often controversial, but our project proves that it can be used responsibly. We manufacture furniture from 100% pre-consumer recycled polyethylene, ready to be recycled repeatedly under controlled conditions. Sourced from fully valuable material left over from the production of planters, kayaks and other large-format elements made in our factory in Poland. This material returns to circulation in the form of durable furniture, instead of ending up as waste.

With full control over the recycling process, we ensure the polyethylene remains uncontaminated and, under controlled conditions, retains its key properties. This exceptional material is resistant to weather, scratches, breaks, and impacts. It's flexible, soft, yet incredibly durable extending the life of each piece.

ADDITIONAL INFORMATION

MAINTENANCE

- Products can be cleaned with warm water and a mild detergent.
- Avoid using harsh cleaning agents that may damage the surface.

TEMPERATURE RESISTANCE

- High-quality polyethylene retains its properties in temperatures ranging from -30°C to +60°C.

WARRANTY

- LOOPE is more than just furniture - it's a thoughtful system that redefines consumption.
- After five years, customers can return their furniture, and we'll transform it into a new product. This way, we extend its life and reduce plastic production. Warranty covers color and shape deformation.

DIGITAL FILE BASE

- PHOTOS
- VISUALIZATIONS
- 2D & 3D FILES